



2026

- IMMERSION BLENDERS & ACCESSORIES
- BLENDERS
- PLANETARY MIXER
- SALAD SPINNERS
- CITRUS JUICERS
- MANUAL DICER

DYNAMIC continues to set the standard in professional food preparation. Driven by innovation and built on decades of expertise, we're proud to present our latest generation of equipment — including the new **BlendPro3 Series, JuicePro Series and LT7 Planetary Mixer**, along with our expanded line of **immersion blenders, salad spinners, and the world's No. 1 manual dicer** — all engineered for performance, durability, and everyday efficiency.

Trusted by foodservice professionals worldwide, **Dynamic** delivers reliable tools that drive creativity, consistency, and excellence in every kitchen.

NEW



EM25
SPINNER
ELECTRIC SALAD DRYER
E008.1



PAGE 21

BLENDPRO3
HIGH PERFORMANCE BLENDER
BL003.1



PAGE 18

BLENDPRO3SE
SHIELDED BLENDER
BL003.1SE



PAGE 18

JUICEPRO1&2
ORANGE JUICERS
JP001.1 / JP002.1



PAGE 22

PAGE 22

LT7 MIXER
PM001.1



PAGE 19

**COMPLETE YOUR
DYNAMIC LINE UP!**



TERMS AND CONDITIONS

PRICING. All prices are subject to change without notice. Prices do not include freight, handling or delivery charges, air shipment charges or taxes (sales, excise, duties, etc.). The Purchaser shall be responsible for collecting and/or paying any and all such taxes. Such charges may, at Dynamic's sole and exclusive discretion, be prepaid by Dynamic and reimbursed by the Purchaser.

APPLICABLE POLICIES FOR RESALE OF PRODUCTS. All product selling prices are determined at the discretion of authorized distributors with the exception of specific products determined by Dynamic to have Minimum Advertised Pricing («MAP»). Failure to comply with our MAP Policy may affect your status as an authorized distributor. Dynamic reserves the right to take the necessary steps in maintaining our integrity with regards to our pricing.

ORDERS. No minimum orders required. Each order must reference Dynamic's quote (if any), the requested Products, and any other information requested by Dynamic. All orders and transactions are subject to acceptance or cancellation by Dynamic, in Dynamic's sole discretion. Each accepted order will be interpreted as a single agreement, independent of any other orders. All orders must be sent by email at orders@dynamicmixers.com.

SHIPPING AND DELIVERY. Prepaid Freight qualifies at \$3000 net (excluding PowerPro) on individual orders shipped to one location. Prepaid Freight Address exclusions are Hawaii, Alaska, Puerto Rico and Canada far North. Additional exclusions may apply. Orders not meeting Prepaid freight criteria are F.O.B. Memphis, TN USA or F.O.B. Montreal, QC. Canada. A fee may apply on 'Drop Ship' orders. Shipping specifics and delivery dates advised are estimates only and Dynamic is not responsible on variances. Dynamic reserves the right to refuse or cancel any order. On occasion, products contained in a single order may ship separately. Dynamic reserves the right to choose the carrier on specific orders. Freight charges are based on product weight & destination zip code or postal code. Product damage or loss incurred during shipment is the sole responsibility of the product purchaser. The purchaser must notify Dynamic regarding any product inconsistencies within 7 days of receipt of order including damages and shortages.

RETURNS. Returns cannot be accepted without a Return Authorization number issued by Dynamic and a return request must be submitted within seven (7) days of invoice date. Product returns must be in original packaging and unopened. Damaged and/or used Products will not be accepted. A 25% restocking charge will apply on all returns. Products deemed «Special Order» cannot be returned.

INVOICING AND PAYMENT. Dynamic may invoice parts of an order separately, or may invoice purchases of Products in one invoice. Invoices are due and payable within the time period noted on the Purchaser's invoice. All Products sold remain the exclusive property of Dynamic until invoice is paid in full.

WARRANTY. Dynamic will guarantee all new Products to be free from defects in materials and workmanship. Electric Products include a one (1) year parts and labor carry in bench warranty with the exception of component replacements necessary through regular "wear and tear". Manual Products include a one (1) year limited parts warranty. Warranty is valid, providing the Products have been used in accordance with Dynamic's operating recommendations and guidelines. Dynamic or any authorized service center will repair or replace, at Dynamic's discretion and after examination, any or all manufacturer's defective parts during the warranty period. Any damage caused by improper use, abuse, dropping, or similar accidental damage resulting in breakage will render the warranty null and void. During the warranty period, only Dynamic or one of its authorized service centers may perform evaluations or repairs to Products. Warranty will be void on any equipment which has been dismantled or tampered with during the warranty period if this has been done by unauthorized centers or personnel.

DISCLAIMER. Specifics contained herein with regards to Product text and/or Product images may change without notice.

■ IMMERSION BLENDERS & ACCESSORIES	6
■ BLENDERS	18
■ PLANETARY MIXER	19
■ SALAD SPINNERS	20
■ CITRUS JUICERS	22
■ MANUAL DICER	23

**PASSION,
COMMITMENT
AND QUALITY
PERSONIFIED
SINCE 1964**

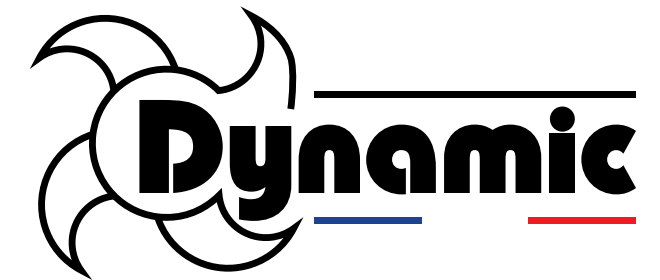

IMMERSION BLENDERS & ACCESSORIES

MINI SERIES



OFFERED IN 7 COLORS

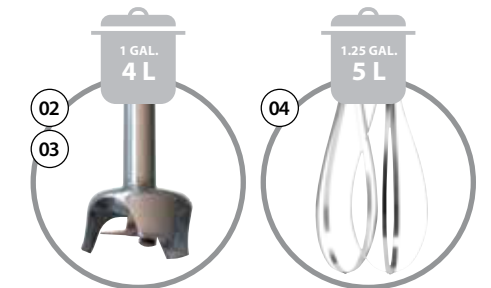

AC520 - 160 mm / 6.5"
AC530 - 190 mm / 7.5"

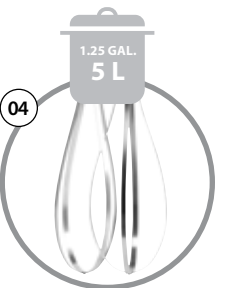

ACS16 - 185 mm / 7"



AC560 - 190 mm / 7.5"



ACS17 - 125 mm / 5"

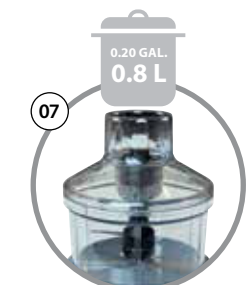

ACS18



ACS10



ACS13



SM030

MiniPro

Reference	MX070.1
Total length	395 mm / 15.5"
Mixer tool length	160 mm / 6.5"
Diameter	70 mm / 2.8"
Actual weight	1.1 Kg / 2.5 lbs
Shipping weight	1.5 Kg / 3.2 lbs
Output	200 W
Speed	0 to 13 000 R.P.M.

MiniPro Blender

Reference	MX069.1
Total length	395 mm / 15.5"
Mixer tool length	160 mm / 6.5"
Diameter	70 mm / 2.8"
Actual weight	1.1 Kg / 2.5 lbs
Shipping weight	1.5 Kg / 3.2 lbs
Output	200 W
Speed	0 to 13 000 R.P.M.

MiniPro Cordless

Reference	MX135.1
Total length	450 mm / 17.7"
Mixer tool length	160 mm / 6.5"
Diameter	70 mm / 2.8"
Actual weight	1.1 Kg / 2.4 lbs
Shipping weight	1.9 Kg / 4.2 lbs
Output	2000 mAh - 12 Vdc
Speed	10 000 R.P.M.

MD95 / MD95E

Total length	445 mm / 17.5"
Mixer tool length	160 mm / 6.5"
Diameter	72 mm / 3"
Actual weight	1.2 Kg / 2.6 lbs
Shipping weight	1.5 Kg / 3.3 lbs
Output	180 W
Speed	9 500 R.P.M.

MD95 with variable speed

Reference	MX010.1.V
Speed	0 to 9 500 R.P.M.

MD95 (MX010.1) with standard blade

MD95E (MX008.1) with emulsifying blade



Dynashake

Reference	MX054.1
Total length	425 mm / 16.7"
Mixer tool length	190 mm / 7.5"
Diameter	95 mm / 3.8"
Actual weight	1.2 Kg / 2.7 lbs
Shipping weight	1.9 Kg / 4.2 lbs
Output	200 W
Speed	0 to 13 000 R.P.M.

Dynashake comes complete with: 1 Dynashake mixer, 1 emulsifying blade, 1 standard blade, 1 batter blade, 1 dairy blade, 1 litre graduated cup + lid

MiniPro comes with 4 blades :



MiniPro Cordless comes complete with :

2 Batteries (AC585 - 20 minutes run-time)
1 Charger (AC590.1 - 45 minutes charge time / battery)



01 - MiniPro motor block

Reference	AC515.1
Total length	205 mm / 8"
Diameter	70 mm / 2.8"
Actual weight	1 Kg / 2.1 lbs
Shipping weight	1.3 Kg / 2.8 lbs
Output	200 W
Speed	0 to 13 000 R.P.M.

- 02 - MiniPro mixer tool with standard blade
- 03 - Dynashake mixer tool with standard blade
- 04 - MiniPro whisk tool
- 05 - MiniPro blender tool
- 06 - MiniPro ricer / food mill
- 07 - MiniPro food processor bowl
- 08 - Dynashake graduated cup with lid
- 09 - MiniPro stainless steel cup
- 10 - MiniPro stand

IMMERSION BLENDERS & ACCESSORIES

JUNIOR SERIES



Option variable speed



225 mm / 9"



Variable speed



185 mm / 7"



Ref. 089959
Wall support included

Junior Standard non-detachable

Reference	MX020.1
Total length	505 mm / 20"
Mixer tool length	225 mm / 9"
Diameter	94 mm / 4"
Actual weight	1.7 Kg / 3.7 lbs
Shipping weight	2.0 Kg / 4.4 lbs
Output	250 W
Speed	9 500 R.P.M.

Junior Whisk non-detachable

Reference	FT005.1
Total length	500 mm / 20"
Whisk length	185 mm / 7"
Diameter	94 mm / 4"
Actual weight	1.4 Kg / 3 lbs
Shipping weight	1.7 Kg / 3.7 lbs
Output	200 W
Speed	0 to 2 000 R.P.M.

Junior Standard non-detachable with variable speed

Reference	MX020.1.V
Speed	0 to 9 500 R.P.M.



Ref. 0880.1 Convenient and secure :
Wall storage bracket for mixer and accessories included with Junior Whisk and motor block.



Variable speed



AC101 - 225 mm / 9"

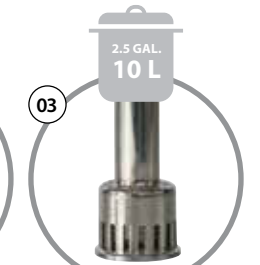

AC066 - 225 mm / 9"

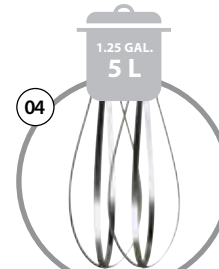

AC102 - 185 mm / 7"

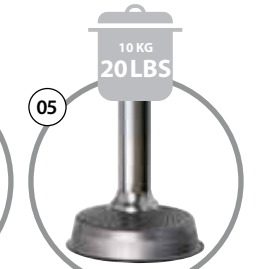

AC103 - 200 mm / 8"



AC104

01 - Junior motor block

Reference	AC100.1
Total length	305 mm / 12"
Diameter	94 mm / 4"
Actual weight	1.9 Kg / 4 lbs
Shipping weight	2.3 Kg / 5 lbs
Output	250 W
Speed	0 to 9 500 R.P.M.

- 01 - Junior motor block
- 02 - Junior mixer tool
- 03 - Junior blender tool
- 04 - Junior whisk tool
- 05 - Junior ricer / food mill
- 06 - Junior processor bowl

IMMERSION BLENDERS & ACCESSORIES

SENIOR SERIES



Option variable speed



PMX98 Standard non-detachable

Reference	MX007.1
Total length	600 mm / 24"
Mixer tool length	300 mm / 12"
Diameter	97 mm / 4"
Actual weight	2.4 Kg / 5.3 lbs
Shipping weight	2.9 Kg / 6.4 lbs
Output	300 W
Speed	9 500 R.P.M.

PMX98 Standard non-detachable with variable speed

Reference	MX007.1.V
Speed	0 to 9 500 R.P.M.



Variable speed

01 - Senior motor block BM250

Included with Senior motor block

Reference	AC005.1
Total length	330 mm / 13"
Diameter	97 mm / 4"
Actual weight	2.0 Kg / 4.4 lbs
Shipping weight	3.1 Kg / 6.8 lbs
Output	300 W
Speed	0 to 9 500 R.P.M.



0880 Wall storage bracket for mixer and accessories

300 watts motor block can be used with the mixer tool and whisk attachment.

- 01 - Senior motor block
- 02 - Senior mixer tool M250
- 03 - Senior ricer / food mill
- 04 - Senior whisk F250



AC006 - 300 mm / 12"

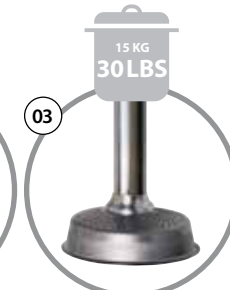

AC004 - 420 mm / 16.5"



AC007 - 205 mm / 8"



Precise alignment of motor block and mixer tool requires only a 1/4 turn to secure.



Ejectable whisks for easy cleaning.



IMMERSION BLENDERS & ACCESSORIES

MASTER SERIES



Option variable speed



410 mm / 16"

Ref. 0881
Wall support included



Option variable speed



410 mm / 16"

Ref. 0862
Wall support included



Variable speed



245 mm / 10"

MX91 *Classic* non-detachable

Reference	MX005.1
Total length	715 mm / 28"
Mixer tool length	410 mm / 16"
Diameter	110 mm / 4.5"
Actual weight	3.4 Kg / 7.5 lbs
Shipping weight	3.8 Kg / 8.4 lbs
Output	460 W
Speed	9 500 R.P.M.

MX91 Classic non-detachable with variable speed

Reference	MX005.1.V
Speed	0 to 9 500 R.P.M.



Emulsifying blade 7910

MX2000 non-detachable

Reference	MX004.1
Total length	720 mm / 28.5"
Mixer tool length	410 mm / 16"
Diameter	122 mm / 5"
Actual weight	3.5 Kg / 7.7 lbs
Shipping weight	4.1 Kg / 9 lbs
Output	460 W
Speed	9 500 R.P.M.

MX2000 non-detachable with variable speed

Reference	MX004.1.V
Speed	0 to 9 500 R.P.M.

Only available for the MX2000



Safety button



Continuous function auto run button also allows to mix continuously by pulse.

FT97 Master Whisk non-detachable

Reference	FT001.1
Total length	650 mm / 25.5"
Whisk tool length	245 mm / 10"
Diameter	110 mm / 4.5"
Actual weight	3.3 Kg / 7.3 lbs
Shipping weight	3.7 Kg / 8.1 lbs
Output	460 W
Speed	0 to 900 R.P.M.

Ejectable wisks for easy cleaning



1A
1B



1A Master motor block BM2000

Reference	AC001.1
Output	460 W

1B Master motor block BM3000

Reference	AC001.1.A
Output	550 W

Included with Master motor blocks



SM020 Mixer weight support clamp

Total length	350 mm / 13.8"
Diameter	122 mm / 4.8"
Actual weight	2.7 Kg / 6.0 lbs
Speed	0 to 9 500 R.P.M.



0880 Wall storage bracket for mixer and accessories



Variable speed



AC002 - 410 mm / 16"

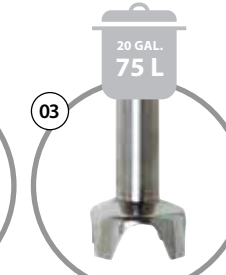

AC500 - 457 mm / 18"



AC070 - 410 mm / 16"



AC003 - 245 mm / 10"



AC004 - 420 mm / 16.5"



- 1A - Master motor block BM2000
- 1B - Master motor block BM3000
- 02 - Master mixer tool M90
- 03 - Master mixer tool M100
- 04 - Master blender tool
- 05 - Master whisk tool F90
- 06 - Master ricer / food mill AP90

09 10 11 Master whip

Reference FM1	AC202
Length FM1	420 mm / 16.5"
Reference FM2	AC200
Length FM2	600 mm / 24"
Reference FM3	AC201
Length FM3	700 mm / 28"
Speed FM1-2-3	0 to 500 R.P.M.

All stainless steel, handle support included.



IMMERSION BLENDERS & ACCESSORIES

SMX SERIES

For all mixers:
Diameter 125 mm / 5"
Speed 11 000 R.P.M.



Model	Power	Height	Capacity
SMX250ES	600W	12"	10 GAL. / 40 L
SMX350ES	600W	14"	15 GAL. / 55 L
SMX450ES	600W	16"	30 GAL. / 115 L
SMX550ES	600W	18"	40 GAL. / 150 L
SMX650ES	650W	21"	50 GAL. / 190 L
SMX750ES	750W	24"	60 GAL. / 225 L
SMX850ES	850W	27"	75 GAL. / 285 L

REFERENCE
MX041.1ES
TOTAL LENGTH
575 mm / 22"
ACTUAL WEIGHT
5.3 Kg / 11 lbs
SHIPPING WEIGHT
6.8 Kg / 15 lbs

REFERENCE
MX042.1ES
TOTAL LENGTH
626 mm / 24"
ACTUAL WEIGHT
5.5 Kg / 12 lbs
SHIPPING WEIGHT
7 Kg / 15.4 lbs

REFERENCE
MX043.1ES
TOTAL LENGTH
676 mm / 26"
ACTUAL WEIGHT
5.7 Kg / 12.6 lbs
SHIPPING WEIGHT
7.2 Kg / 16 lbs

REFERENCE
MX044.1ES
TOTAL LENGTH
728 mm / 28"
ACTUAL WEIGHT
5.9 Kg / 13 lbs
SHIPPING WEIGHT
7.4 Kg / 16.3 lbs

REFERENCE
MX002.1ES
TOTAL LENGTH
800 mm / 31.5"
ACTUAL WEIGHT
6.1 Kg / 13.4 lbs
SHIPPING WEIGHT
7.7 Kg / 17 lbs

REFERENCE
MX040.1ES
TOTAL LENGTH
870 mm / 34"
ACTUAL WEIGHT
6.5 Kg / 14.3 lbs
SHIPPING WEIGHT
8 Kg / 17.6 lbs

REFERENCE
MX001.1ES
TOTAL LENGTH
950 mm / 37.5"
ACTUAL WEIGHT
6.7 Kg / 14.7 lbs
SHIPPING WEIGHT
8.2 Kg / 18 lbs

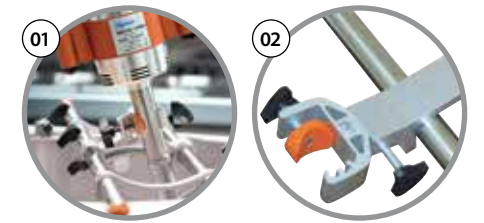

01 Top mounted support brackets 02 Side mounted support brackets

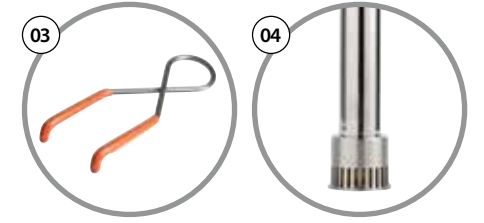

03 SM020 04 AC072T - 17"

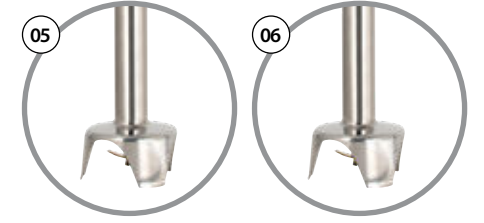

05 AC075T - 24" 06 AC076T - 27"

01-Top mounted support brackets

	Dimension	Weight	CODE
SM4	400 mm / 16"	1.9 Kg / 4.2 lbs	SM001
SM6	600 mm / 24"	2.3 Kg / 5 lbs	SM002
SM8	800 mm / 32"	2.6 Kg / 5.7 lbs	SM003
SM10	1000 mm / 40"	2.8 Kg / 6.2 lbs	SM004
SM12	1200 mm / 48"	3.2 Kg / 7 lbs	SM005

02-Side mounted support brackets

	Weight	CODE
SA	0.7 Kg / 1.5 lbs	SM006

All brackets are easily dismantled and can be cleaned in the dishwasher. Adaptable only for Master and SMX series of mixers. Adjustable length. Practical and convenient, allows adjustable height and angle.

03-Mixer weight support clamp SM020

Mixer weight support clamp included with the Master detachable mixers, the SMX750ES and the SMX850ES.

04-SMX blender tool AC072T (only for SMX750ES and SMX850ES)

Total length	432 mm / 17"
Capacity	200 L

05-Mixer tool for SMX750ES AC075T

Total length	610 mm / 24"
Capacity	225 L

06-Mixer tool for SMX850ES AC076T

Total length	686 mm / 27"
Capacity	300 L



IMMERSION BLENDERS & ACCESSORIES

POWER PRO MOBILE MIXER



REFERENCE	TB002
VOLTAGE	230V, 3 phase, 50/60Hz
SPEED	0 to 4000 R.P.M.

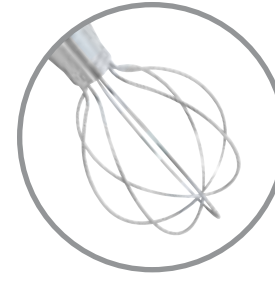
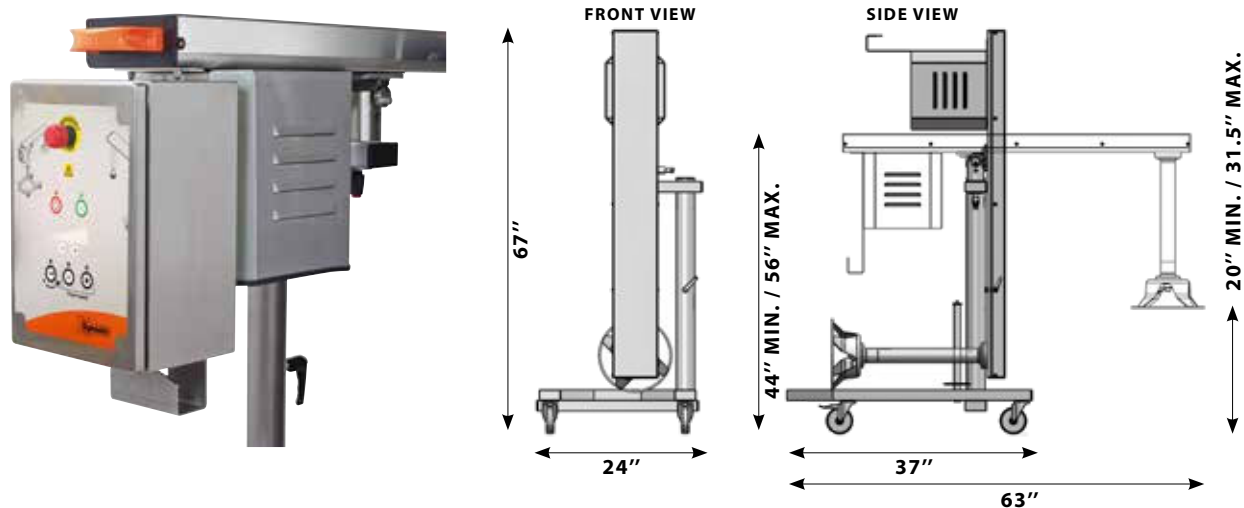

Whisk tool

Variable speed compulsory

Reference	TB014
Speed	2 800 – 4 000 R.P.M.
Speed 1	800 R.P.M.
Speed 2	1 600 R.P.M.
Diameter	170 mm / 6.5"
Height	470 mm / 18.5"

The whisk tool is ideal for delicate recipes and provides the ultimate in mixing flexibility.



Blender tool

Reference	TB004
Speed	2 800 to 4 000 R.P.M.
Diameter	100 mm / 3.8"
Height	90 mm / 3.5"

The blender tool is ideal for emulsifying soups and sauces.



Mixer tool

Reference	TB012
Speed	2 800 – 4 000 R.P.M.
Speed 1	800 R.P.M.
Speed 2	1 600 R.P.M.
Diameter	280 mm / 11"
Height	160 mm / 6.5"

The mixer tool is ideal for mixing large preparations like soups and sauces in less than 5 minutes.



Potato masher tool

Variable speed compulsory

Reference	TB013
Speed 1	800 R.P.M.
Speed 2	1 600 R.P.M.
Diameter	147 mm / 5.8"
Height	251 mm / 9.9"

The potato masher tool is designed for high volume purées that require 50 to 150 kg of potatoes.



Foot Extension

Reference	TB015
Speed	-
Diameter	-
Height	300 mm / 12"

Allows for additional foot depth for added mixing flexibility.



01 Dispenser pump

Reference	TB030 (TB004 required)
Speed	-
Diameter	178 mm / 7"
Height	90 mm / 3.5"

The pump has a 2.5 m (8'2") long rubber tube which allows for an effortless and fast transfer of food preparations. Tube diameter 19mm (3/4"). Adaptable on the blender tool only (sold separately).

02 Portion control gun

Reference	TB040 (TB030 required)
Speed	-
Length	202 mm / 8"
Height	243 mm / 9.6"

The gun can be used as a complimentary tool for the transfer of food preparations in smaller containers. Adaptable on the pump attachment only (sold separately).

NEW

NEW



BLENDPRO3
Capacity 68 Ounces (2 Liters)

Reference	BL003.1
Shipping weight	~ 10.5 lbs (4.8 kg)
Box dimensions (in)	16" X 8.5" X 9.25"
Box dimensions (cm)	41 X 22 X 24 cm
Cubic measure	1.6 ft ³ / 0.05 m ³
Voltage	115 V or 230 V

- 3 H.P.
- Light weight
- Front and back of the house

BLENDPRO3SE
Capacity 68 Ounces (2 Liters)

Reference	BL003.1SE
Shipping weight	~ 15.5 lbs (7.03 kg)
Box dimensions (in)	10" X 10" X 19"
Box dimensions (cm)	25 X 25 X 48 cm
Cubic measure	1.9 ft ³ / 0.05 m ³
Voltage	115 V or 230 V

- 3 H.P.
- Light weight
- Front and back of the house
- Integrated sound enclosure with 80% noise reduction and convenient tool free removal



Container only.
BL756DT - Capacity: 2L



Container only.
BL756CT - Capacity: 4L



Blend-in-cup
travel bottle
BL900



Blend-in-cup
cutting base
BL110



Premium
Touchscreen
Interface



LT7
Capacity 7 Liters / 8 Quarts

Reference	PM001.1
Shipping weight	~ 65 lbs (29.5 kg)
Box dimensions (in)	20" x 11.5" x 18"
Box dimensions (cm)	51 x 30 x 46 cm
Cubic measure	~ 2.4 ft ³ / 0.07 m ³
Voltage	115 V or 230 V

Includes Three
Professional-Grade Attachments



Wire Whip



Flat Beater



Dough Hook

- 7L/8QT brushed stainless steel bowl w/handle
- Includes dough hook, batter beater and whip
- Removable polycarbonate safety guard
- 11 mixing speeds and 30 minute timer with 30 second increments
- Electronic touch screen with intuitive timer and speed adjustments
- Advanced drive system allowing for quiet operation
- Adjustable head lift knob for easy control
- Integrated metal housing with no exposed screws



SSB1 Stabilizing base*

* FOR SD92, SD92SC AND EM98

TOTAL HEIGHT
170 mm / 6.7"
DIAMETER
360 mm / 14.2"



E002

SD92 Manual salad spinner



E004

SD92SC Manual salad spinner SEALED COVER



E002.B

SD92 Manual salad spinner with stabilizing base



E004.B

SD92SC Manual salad spinner SEALED COVER with stabilizing base



E007

SD MINI Manual salad spinner sealed cover



TOTAL HEIGHT
342 mm / 13.5"
DIAMETER
275 mm / 10.8"
ACTUAL WEIGHT
1.6 Kg / 3.5 lbs
SHIPPING WEIGHT
1.6 Kg / 3.5 lbs

Maximum
2 heads of lettuce



E001

SD99 Manual salad spinner



TOTAL HEIGHT
460 mm / 18"
DIAMETER
330 mm / 13"
ACTUAL WEIGHT
2.4 Kg / 5.3 lbs
SHIPPING WEIGHT
3.1 Kg / 6.8 lbs

Maximum
4 heads of lettuce



WITH 1-MINUTE TOUCH BUTTON TIMER AND COMPLETE SEALED COVER



E003.1.B.T

EM98 Electric salad spinner with stabilizing base SSB1



TOTAL HEIGHT
630 mm / 25"
DIAMETER
430 mm / 17"
ACTUAL WEIGHT
8.3 Kg / 18.3 lbs
SHIPPING WEIGHT
10 Kg / 22 lbs
OUTPUT
200 W
SPEED
500 R.P.M.

NEW



E008.1

EM25 Electric salad spinner



TOTAL HEIGHT
460 mm / 18"
DIAMETER
330 mm / 13"
ACTUAL WEIGHT
2.4 Kg / 5.3 lbs
SHIPPING WEIGHT
3.1 Kg / 6.8 lbs
OUTPUT
200 W
SPEED
500 R.P.M.

CITRUS JUICERS JUICEPRO / PA96

NEW



JUICEPRO1

Production: up to 12 oranges per minute

Reference	JP001.1
Shipping weight	~ 65 lbs (29.5 kg)
Net weight	~ 60 lbs (27 kg)
Box dimensions (in)	15" x 18" x 32"
Box dimensions (cm)	38 x 46 x 81 cm
Cubic measure	~ 5.0 ft ³ / 0.14 m ³
Voltage	115 V or 230 V

- Feeder capacity 3 oranges
- Orange diameter max 75mm / 3 inches approx

JUICEPRO2

Production: up to 25 oranges per minute

Reference	JP002.1
Shipping weight	~ 85 lbs (38.5 kg)
Net weight	~ 80 lbs (36.3 kg)
Box dimensions (in)	22" x 18" x 33"
Box dimensions (cm)	56 x 46 x 84 cm
Cubic measure	~ 7.5 ft ³ / 0.21 m ³
Voltage	115 V or 230 V

- Feeder capacity 6-7 oranges
- Orange diameter max 85mm / 3 ¼ inches approx

PA96

Production: up to 6 oranges per minute

(depending on fruit size and operator speed)

Reference	PA001.1
Total length	330 mm / 13"
Diameter	220 mm / 8.6"
Actual weight	6.3 Kg / 13.9 lbs
Voltage	115 V or 230 V
Output	200 W
Speed	1 500 R.P.M.

- 2 juicing cones included



MANUAL DICER DYNACUBE



Grid set with pusher.
Cutting grid sizes are estimates only.

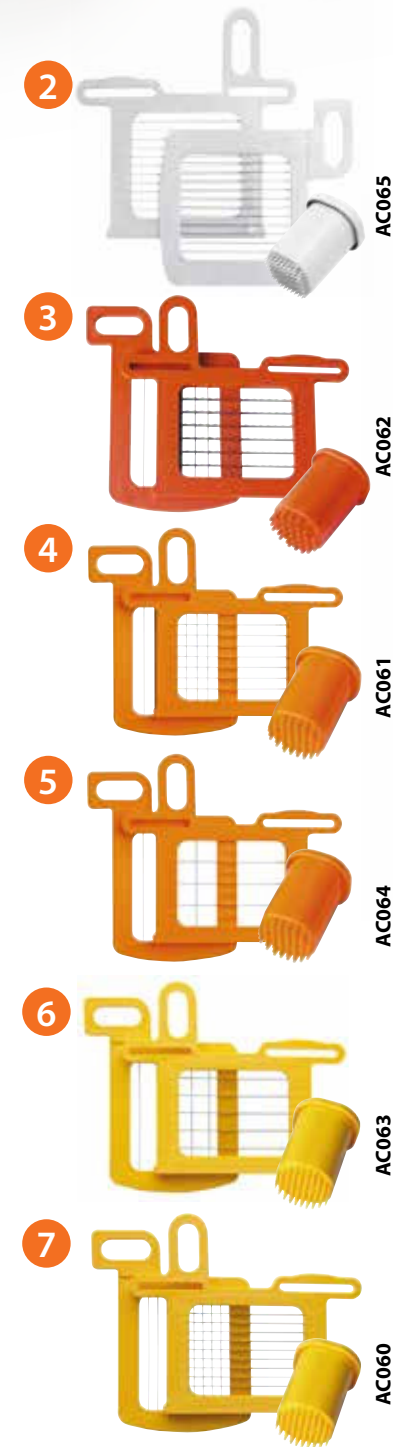

1

DYNACUBE

N°1 MANUAL DICER in the world!

Total height	330 mm / 13"
Diameter	400 mm / 15.8"
Actual weight	3.1 Kg / 6.8 lbs
Shipping weight	4.4 Kg / 9.7 lbs



Demo Video

- No direct contact with blades
- 6 cutting grid sizes available
- Versatile
- 100% Product yield and consistent cuts

1 Dynacube	+	2 AC065 - 5x5mm / 3/32" x 3/32"	=	CL007
1 Dynacube	+	3 AC062 - 10x10mm / 3/8" x 3/8"	=	CL006
1 Dynacube	+	4 AC061 - 8.5x,5mm / 1/4" x 1/4"	=	CL003
1 Dynacube	+	5 AC064 - 17x17mm / 3/4" x 3/4"	=	CL009
1 Dynacube	+	6 AC063 - 14x14mm / 1/2" x 1/2"	=	CL008
1 Dynacube	+	7 AC060 - 7x7mm / 1/8" x 1/8"	=	CL005



 **DYNAMIC USA**
1320 ROUTE 9 #1352 CHAMPLAIN, NY - 12919
dynamicmixersusa.com

 **DYNAMIC CANADA**
3227 BOUL. PITFIELD, MONTREAL, QUEBEC - H4S 1H3
dynamicmixers.ca

GENERAL
info@dynamicmixers.com

ORDERS
orders@dynamicmixers.com

CUSTOMER SERVICE
800.267.7794 / 514.956.0127



**GROUPE
NADIA**